

Hydro-acoustic resonance behavior in presence of a precessing vortex rope: observation of a lock-in phenomenon at part load Francis turbine operation

A Favrel¹, C Landry¹, A Müller¹, K Yamamoto¹ and F Avellan¹

¹EPFL Laboratory for Hydraulic Machines, Avenue de Cour 33bis 1007 Lausanne, Switzerland

E-mail: arthur.favrel@epfl.ch

Abstract. Francis turbines operating at part load condition experience the development of a cavitating helical vortex rope in the draft tube cone at the runner outlet. The precession movement of this vortex rope induces local convective pressure fluctuations and a synchronous pressure pulsation acting as a forced excitation for the hydraulic system, propagating in the entire system. In the draft tube, synchronous pressure fluctuations with a frequency different to the precession frequency may also be observed in presence of cavitation. In the case of a matching between the precession frequency and the synchronous surge frequency, hydro-acoustic resonance occurs in the draft tube inducing high pressure fluctuations throughout the entire hydraulic system, causing torque and power pulsations. The risk of such resonances limits the possible extension of the Francis turbine operating range. A more precise knowledge of the phenomenon occurring at such resonance conditions and prediction capabilities of the induced pressure pulsations needs therefore to be developed.

This paper proposes a detailed study of the occurrence of hydro-acoustic resonance for one particular part load operating point featuring a well-developed precessing vortex rope and corresponding to 64% of the BEP. It focuses particularly on the evolution of the local interaction between the pressure fluctuations at the precession frequency and the synchronous surge mode passing through the resonance condition. For this purpose, an experimental investigation is performed on a reduced scale model of a Francis turbine, including pressure fluctuation measurements in the draft tube and in the upstream piping system. Changing the pressure level in the draft tube, resonance occurrences are highlighted for different Froude numbers. The evolution of the hydro-acoustic response of the system suggests that a lock-in effect between the excitation frequency and the natural frequency may occur at low Froude number, inducing a hydro-acoustic resonance in a random range of cavitation numbers.

1. Introduction

Extending the operating range of Francis turbines, they experience the development of a swirling flow at the runner outlet in the draft tube cone. At part load condition, it results of the development of a precessing vortex rope in the draft tube, as investigated by Nishi et al [1]. It induces local convective pressure fluctuations in the draft tube, which are not known to propagate into the entire hydraulic system, see Arpe [2]. However, Nishi et al [3] showed that the interaction between the precessing vortex rope and the draft tube elbow induces a fluctuation of the pressure recovery in the draft tube. It acts as an excitation source for the hydraulic system and induces synchronous pressure pulsations able to propagate into the hydraulic system and provoke torque and power fluctuations of the hydro power plant, as observed by Rheingans [4]. At low pressure

level in the draft tube, the cavitation vortex rope introduces an additional compressibility in the draft tube cone. It has been modeled first by Brennen et al [5] by introducing a key parameter, the cavitation compliance, in order to calculate the dynamic transfer matrix of a cavitating pump. In a case of a Francis turbine, the cavitation compliance was computed first by Dörfler [6] for different pressure levels using a one-dimensional model of the turbine dynamics. Other improved one-dimensional hydro-acoustic models were proposed by several authors, for instance Couston et al [7] or more recently Alligné et al [8]. Under certain operating conditions, the first hydro-acoustic natural frequency of the system can match the precession frequency, inducing a hydro-acoustic resonance. The cavitation volume consequently pulsates at that same natural frequency, inducing a time-dependent cavitation compliance and a strong dissipative effect due to the phase changing during one volume pulsation period, see Alligné [9]. Such a resonance was experimentally observed by Favrel et al [10] and simulated numerically using one-dimensional hydro-acoustic models, see Alligné et al [11] and Nicolet et al [12]. However, the strong non-linearities of the system at resonance conditions make the prediction of the pressure fluctuations by 1D hydro-acoustic models unreliable, since they do not account for non-linear effects.

As the occurrence of resonance is a problem for the extension of the operating range of Francis turbine at partial load, a better understanding of the phenomenon is necessary. This paper proposes to investigate experimentally the occurrence of hydro-acoustic resonance excited by the cavitation vortex rope at a particular part load regime. For this purpose, a series of measurement are performed on a reduced scale model Francis turbine installed on EPFL test rig PF3. The investigation is focused on one operating point featuring a well-developed precessing vortex rope, corresponding to 64% of the discharge at the Best Efficiency Point. Performing dynamic pressure measurements in the draft tube, the evolution of the hydro-acoustic response of the system with the cavitation number is highlighted and resonance occurrence is identified. Finally, the analysis is focused on the influence of the Froude number on the range of resonance condition. It permits to highlight an obvious dependence of the interaction between the cavitation volume and the excitation source on the Froude number.

2. Experimental setup

Experimental investigations are performed on a reduced scale model Francis turbine installed on EPFL test rig PF3 operating in closed-loop configuration. Two axial double-volute pumps generate the specified head and the discharge is adjusted with the guide vane opening. The cavitation number is adjusted by varying the pressure over the free surface in the reservoir using a vacuum pump. Dynamic pressures are measured at different locations of the draft tube and the feeding pipe by flush-mounted piezo-resistive transducers. Figure 1 illustrates the upper part of the hydraulic circuit, with the different locations of the sensors.

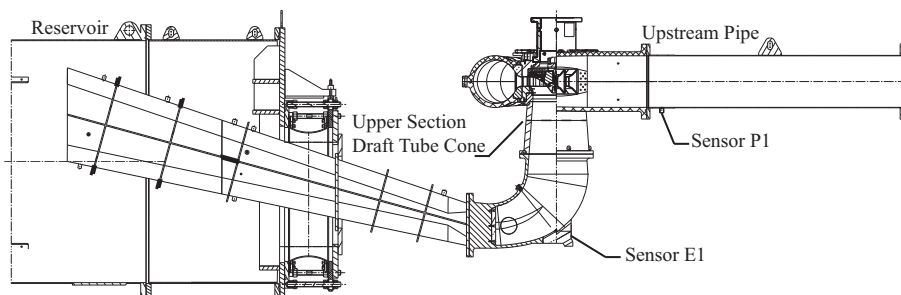

Figure 1: Upper part of the EPFL test rig PF3.

In the upper cross-section of the draft tube cone, 4 sensors are arranged spaced by 90° (figure 2), permitting to decompose the pressure fluctuations at the precession frequency in the cone into convective and synchronous components. One sensor (P1) is arranged in the upstream pipe to characterize the hydro-acoustic response of the test rig independently of the convective component. A last sensor is placed in the lower part of the draft tube elbow (sensor E1).

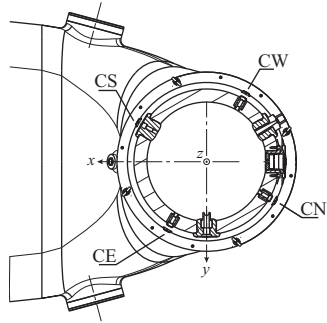

Figure 2: Cut-view of the upper section of the draft tube cone, with the position of the dynamic pressure sensors.

Dynamic pressures at the different locations are measured synchronously with a sampling frequency of 1000 Hz and an acquisition time of 180 s. They are also synchronized with a measurement of the shaft torque and the runner speed, in order to highlight the mechanical effects of resonance condition, but the corresponding results are not presented in the present paper.

3. Selected operating point

This investigation is focused on a particular operating point at part load, corresponding to 64% of the discharge flow at the BEP. The speed factor n_{ED} is kept constant and corresponds to the prototype value. The parameters of the investigated operating point are given in table 1.

Table 1: Parameters of the operating point.

n_{ED} (-)	Q_{ED} (-)	$Q_{ED}/Q_{ED,BEP}$ (%)
0.288	0.128	64

These operating conditions correspond to a flow regime featuring a well-developed precessing vortex rope, although the typical helical shape of the vortex rope is not clearly observed. At this point, the cavitation vortex rope impacts the inner part of the elbow as observed and modeled by Nicolet et al [13], but its effects are not studied in the present paper.

4. Spectral analysis of the pressure fluctuations

A spectral density function analysis of the pressure fluctuations is performed to highlight the frequencies of interest and their physical nature. For this purpose, the individual pressure signals are first made dimensionless by the head and shared into 20 sub-signals of 2^{14} samples with an overlapping of 50%. The auto-spectral and cross-spectral density functions are estimated by an ensemble averaging procedure using a Hann window to suppress the leakage problem, see [14]. Figure 3 presents an example of cross-spectral analysis of two pressure signals measured in

the same section of the draft tube cone (positions CE and CS). The cavitation number for this point is equal to 0.11, corresponding to the prototype condition for which the cavitation volume of the vortex rope is large. The coherence C_{xy} , the amplitude $|G_{xy}|$ and the phase θ_{xy} of the cross-spectral density function are plotted against the dimensionless frequency f/n , from 0 to 0.8 times the runner frequency.

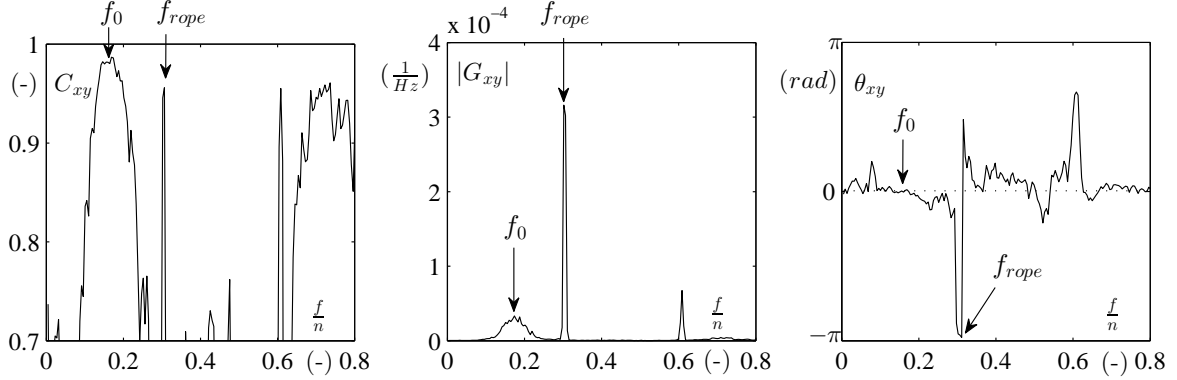

Figure 3: Cross-spectral analysis of two pressure signals measured in the cross-section of the cone. The cavitation and Froude numbers are respectively equal to 0.11 (prototype conditions) and 8.75.

Two types of pressure fluctuations with a high coherence are identified in these conditions. The first one corresponds to pressure fluctuations at f_{ropc} , the vortex rope precession frequency. They result from the sum of purely convective fluctuations and synchronous fluctuations induced by the excitation source. The first harmonic of the precession frequency is also highlighted but it features lower amplitude. A second type of fluctuations with a high coherence is highlighted in a broad range of frequencies centered on f_0 . As the phase shift between two sensors in the same cross-section of the draft tube cone is equal to 0 at this frequency, these fluctuations may be identified as synchronous type and correspond to a self-oscillation of the cavitation volume at the natural hydro-acoustic frequency f_0 of the draft tube. This assumption is confirmed in the next section by the evolution of f_0 with the cavitation number.

5. Sigma Influence

For the selected operating point, the pressure level in the reservoir is increased step by step in order to survey a large range of cavitation number, from 0.11 to free-cavitation conditions. The Froude number is fixed at 8.75, with the runner frequency and the head equal to respectively 13.3 Hz and 26.8 m. The resonance is identified as being the conditions experiencing the most important hydro-acoustic response at the precession frequency in the upstream pipe (sensor P1). Figure 4 shows the frequencies f_0 and f_{ropc} (left-hand graph) and the auto-spectra amplitude at f_{ropc} measured in P1 (right-hand graph) as a function of the cavitation number.

The frequency f_0 evolves quasi linearly with the cavitation number, with a variation from 2.3 Hz at $\sigma = 0.11$ to 5.9 Hz at $\sigma = 0.19$. For higher cavitation numbers, the cavitation volume disappears and the frequency f_0 cannot be clearly identified by a cross-spectral analysis. This result confirms that this frequency corresponds to the natural hydro-acoustic frequency of the draft tube and the cavitation volume auto-oscillates at this frequency. The cavitation number does not affect strongly the precession frequency, which remains constant from $\sigma = 0.165$ to $\sigma = 0.38$ (atmospheric conditions). Regarding the evolution of the auto-spectra amplitude at the precession frequency in P1, the resonance occurs in the range $\sigma = [0.1575 - 0.1625]$. In this range, the natural frequency f_0 matches with the precession frequency f_{ropc} .

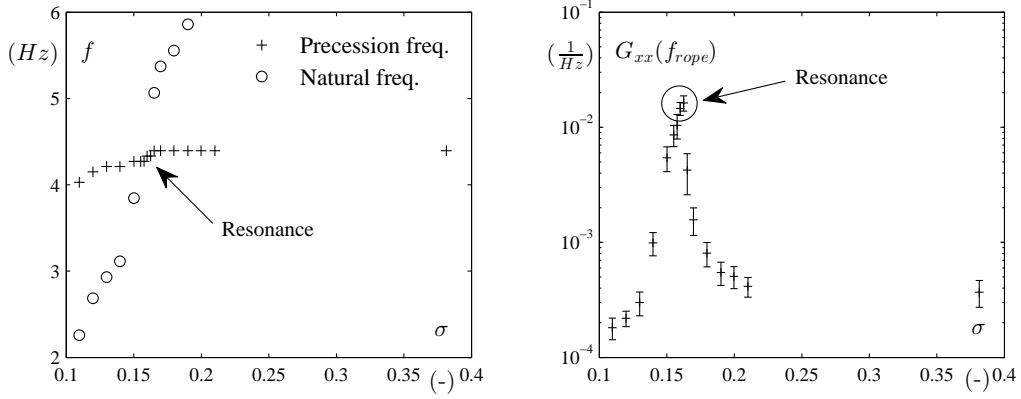

Figure 4: Auto-spectra amplitude at the precession frequency (in P1) and frequencies of interest plotted against the cavitation number ($Fr = 8.75$).

The local pressure fluctuations in the draft tube cone are now investigated. A first analysis of the phase shift at the precession frequency between pressure signals measured in the same section of the cone permits to highlight the pressure fluctuations nature in the draft tube for the different cavitation conditions. Figure 5 shows the evolution of the phase shift for 4 pairs of pressure signals measured in the cone section at positions spaced by 90° .

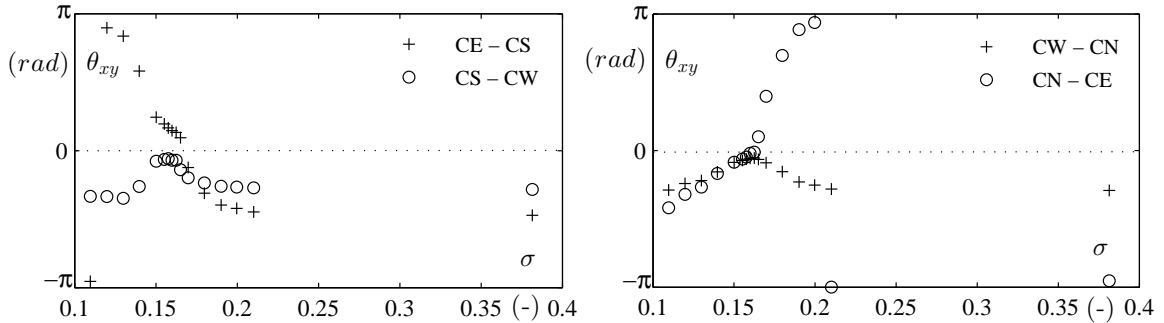

Figure 5: Phase shift at the precession frequency for 4 pairs of pressure signals measured in the draft tube cone as a function of the cavitation number ($Fr = 8.75$).

Approaching the resonance conditions, the phase shift at f_{rope} between two signals in the cross-section of the cone converges to 0. It confirms that the synchronous component at f_{rope} becomes preponderant in resonance conditions, as highlighted in the previous study [10]. Thus, the pressure fluctuations at the precession frequency in resonance conditions are almost purely synchronous and characterized by high amplitude, imposing a periodic pulsation of the cavitation volume at the same frequency. Increasing again the cavitation number, the phase shift converges smoothly from 0 to a final value corresponding to the value in atmospheric conditions. It is interesting to note that passing through the resonance conditions, the sign of the phase shift for two pairs of pressure signals (CN-CE and CE-CS) changes whereas it remains the same for the other two (CS-CW and CW-CN).

6. Froude influence

The occurrence of resonance is now investigated for different Froude numbers at the same operating point. The Froude number is defined as:

$$Fr = \sqrt{\frac{H}{D}} \quad (1)$$

with H the head and D the diameter of the runner. Changing the head and accordingly the discharge and the runner speed, the Froude number is modified keeping constant the discharge factor Q_{ED} and the speed factor n_{ED} . A total of 4 Froude numbers are investigated (see table 2).

Table 2: Parameters for the different investigated Froude numbers.

Fr	n (Hz)	H (m)	Q ($\text{m}^3 \cdot \text{s}^{-1}$)
9.84	15.0	33.9	0.286
8.75	13.3	26.8	0.254
7.66	11.7	20.5	0.222
6.56	10.0	15.1	0.191

Figure 6 shows the auto-spectral amplitude at the precession frequency in P1 as a function of the cavitation number for each Froude number. Resonance occurs around $\sigma = 0.16$ for each Froude number.

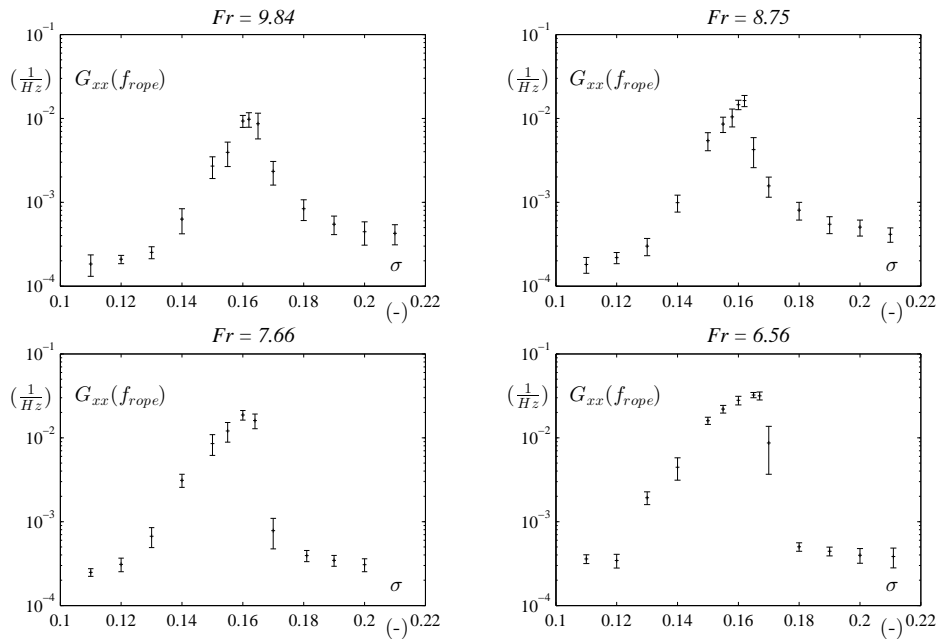

Figure 6: Auto-spectra amplitude at the precession frequency (in P1) plotted against the cavitation number for different Froude numbers.

Changing the Froude number, some modifications can be notified. First, the auto-spectra amplitude at the precession frequency in resonance conditions increases when the Froude number decreases. Moreover, the shape of the evolution is quite different decreasing the Froude number. For high Froude numbers, the evolution of the amplitude from resonance conditions to atmospheric conditions is smooth whereas the transition is quite sudden for low Froude numbers. This phenomenon is really obvious for $Fr = 6.56$. The system remains blocked in resonance conditions, and then transition suddenly to atmospheric conditions. These observations are confirmed by the evolution of the phase shift in the cone with the cavitation number for the different Froude numbers, see figure 7. The evolution of the phase shift at f_{rope} for $Fr = 6.56$ features a sudden jump from resonance value to atmospheric value.

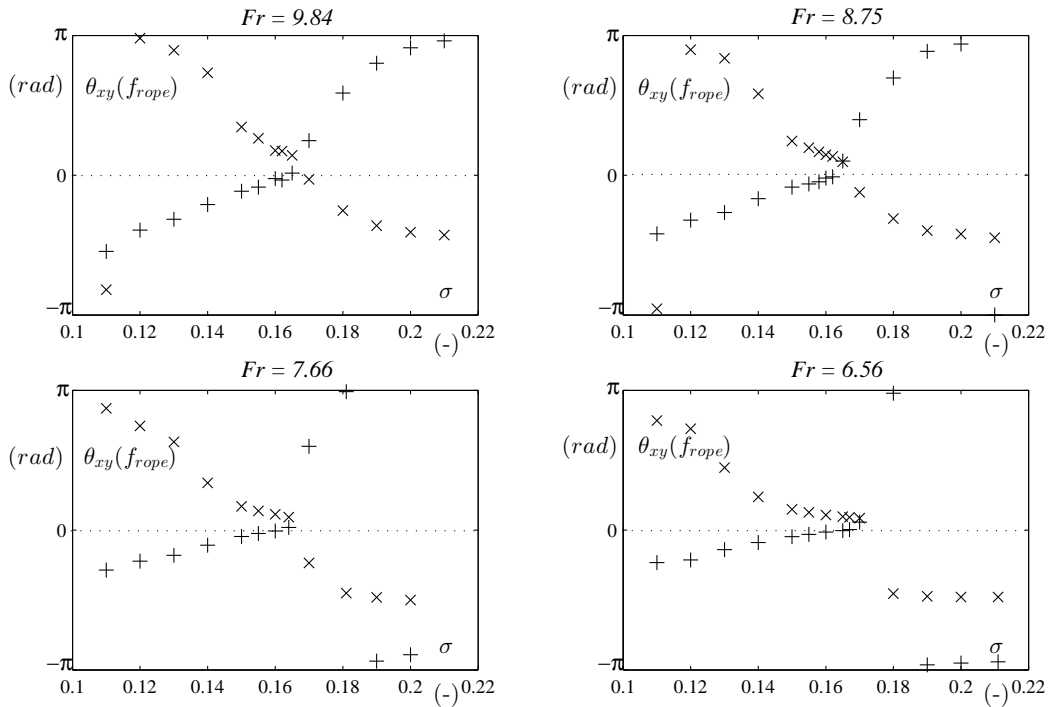

Figure 7: Phase shift at the precession frequency of 2 pairs of pressure signal measured in the draft tube cone plotted against the cavitation number for different Froude numbers. + and \times corresponds respectively to the pairs CN-CE and CE-CS.

A second record with a Froude number equal to 6.56 is performed in order to confirm the previous results. Figure 8 shows the evolution of the precession frequency (left-hand graph) and the auto-spectra amplitude at that same frequency in P1 (right-hand graph) with the cavitation number.

The evolution of the amplitude suggests clearly that the system experiences resonance condition over a large range of cavitation number value, approximately from $\sigma = 0.16$ to $\sigma = 0.175$ (zone 2 between the dashed lines in figure 8). In this range, the precession frequency is constant. This suggests that a lock-in phenomenon between the precession frequency, acting as an excitation frequency, and the natural hydro-acoustic frequency of the draft tube occurs in a random range of cavitation number. The lock-in is followed by a sudden jump of the system from resonance conditions to atmospheric conditions (zone 3 in figure 8), without smooth transition.

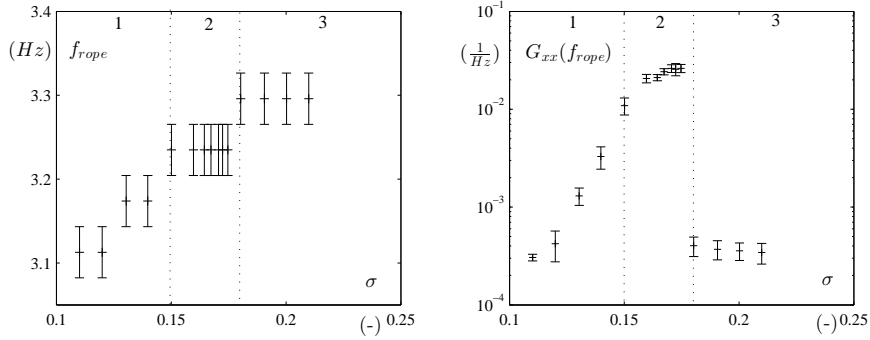

Figure 8: Precession frequency and auto-spectra amplitude at that same frequency (in P1) as a function of the cavitation number - second record at $Fr = 6.56$.

7. Conclusion

The occurrence of resonance excited by a cavitation vortex rope is investigated at a particular partial load operating point, by performing dynamic pressure measurements in the draft tube and in the upstream pipe. As expected, two different types of fluctuation are highlighted: a synchronous one, which is identified as a self-oscillation of the cavitation volume at the natural hydro-acoustic frequency of the draft tube and one at the precession frequency, resulting of the combination of both convective and synchronous components. Increasing the cavitation number, the natural frequency increases and matches the precession frequency. Hydro-acoustic resonance occurs and is characterized by quasi-synchronous pressure pulsations of high amplitude in the draft tube cone, inducing pulsations of the cavitation volume at the same frequency.

The influence of the Froude number on the resonance occurrence has also been investigated. The resonance is found to occur around $\sigma = 0.16$ for all Froude numbers. Moreover, decreasing the Froude number, a particular behavior of the system is highlighted. For low Froude numbers, the system remains blocked in resonance conditions over a large range of cavitation numbers. The precession frequency and consequently the natural frequency remind constant in this range. This result suggests that a lock-in effect between the excitation frequency and the natural frequency may occur for low Froude numbers. Increasing again the pressure level, the system transitions suddenly from resonance conditions to atmospheric conditions.

This new observed phenomenon introduces an additional difficulty for resonance prediction. The next study will be focused on the influence of the Froude number on the evolution of the natural frequency with the cavitation number. Moreover, a resonance model taking into account the non-linear effects must be developed.

Acknowledgments

The research leading to the results published in this paper is part of the HYPERBOLE research project, granted by the European Commission (ERC/FP7- ENERGY-2013-1-Grant 608532). The authors would also like to thank BC Hydro for making available the reduced scale model, in particular Danny Burggraeve and Jacob Iosfin. Moreover, the authors would like to acknowledge the commitment of the Laboratory for Hydraulic Machines' technical staff, especially Georges Crittin, Maxime Raton, Alain Renaud and Vincent Berruex.

Nomenclature

BEP	Best Efficiency Point	n_{ED}	IEC speed factor (-)
Fr	Froude number (-)	Q	Discharge ($\text{m}^3 \cdot \text{s}^{-1}$)
H	Head (m)	Q_{ED}	IEC discharge factor (-)
n	Runner frequency (Hz)	σ	Thoma number (-)

References

- [1] Nishi M and Liu S 2013 *International Journal of Fluid Machinery and Systems* **6** 33–48
- [2] Arpe J 2003 *Analyse du champ de pression pariétale d'un diffuseur coudé de turbine Francis* Ph.D. thesis no. 2779, Ecole polytechnique fédérale de Lausanne, Switzerland
- [3] Nishi M, Matsunaga S, Kubota T and Senoo Y 1980 *Proceedings of the 10th IAHR Symposium, Tokyo, Japan* vol 1 pp 557–568
- [4] Rheingans W 1940 *Transactions of the ASME* **62** 171–184
- [5] Brennen C and Acosta A 1976 *Journal of Fluids Engineering, Transactions of the ASME* **98 Ser 1** 182–191
- [6] Dörfler P 1980 *Proceedings of the 11th IAHR Symposium on Operating Problem of Pump Stations and Powerplants, Amsterdam, Netherlands*
- [7] Coustou M and Philibert R 1998 *The International Journal on Hydropower and Dams* **1** 146–158
- [8] Alligné S, Nicolet C, Tsujimoto Y and Avellan F 2014 *Journal of Hydraulic Research* 1–13
- [9] Alligné S 2011 *Forced and Self Oscillations of Hydraulic Systems Induced by Cavitation Vortex Rope of Francis Turbines* Ph.D. thesis no. 5117, Ecole polytechnique fédérale de Lausanne, Switzerland
- [10] Favrel A, Landry C, Müller A and Avellan F 2012 *IOP Conference Series: Earth and Environmental Science* vol 15 (IOP Publishing)
- [11] Alligné S, Nicolet C and Avellan F 2011 *Proceedings of the 7th International Symposium on Pumping Machinery, Hamamatsu, Japan* vol 1 pp 481–493
- [12] Nicolet C, Herou J, Greiveldinger B, Allenbach P, Simond J and Avellan F 2006 *Proceedings of the 1st IAHR Workgroup on Cavitation and Dynamics Problems in Hydraulic Machinery and Systems, Barcelona, Spain*
- [13] Nicolet C, Arpe J and Avellan F 2004 *Proceedings of the 22nd IAHR Symposium on Hydraulic Machinery and Systems, Stockholm, Sweden*
- [14] Bendat J S and Piersol A G 2010 *Random data: Analysis and measurement procedures* 4th ed (Wiley)